

Programming OpenMP

NUMA

Christian Terboven

The logo for RWTH Aachen University, consisting of the text "RWTHAACHEN" in a bold, blue, sans-serif font above the word "UNIVERSITY" in a lighter blue, sans-serif font.

OpenMP: Memory Access

How To Distribute The Data ?

```
double* A;  
A = (double*)  
    malloc(N * sizeof(double));
```

```
for (int i = 0; i < N; i++) {  
    A[i] = 0.0;  
}
```

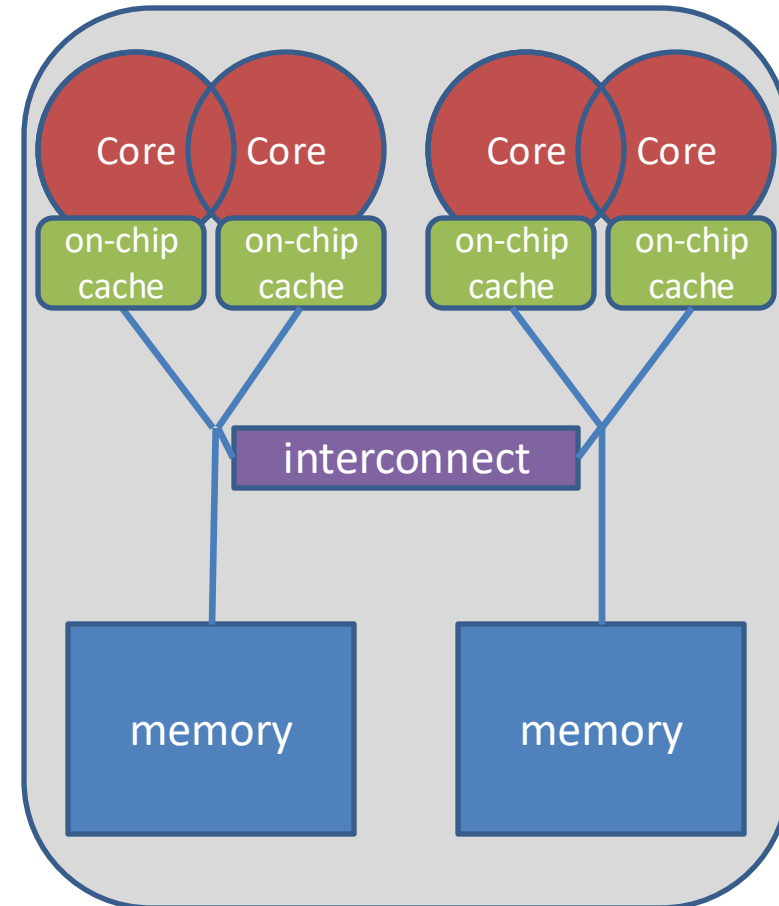

Non-uniform Memory

- Serial code: all array elements are allocated in the memory of the NUMA node closest to the core executing the initializer thread (first touch)

```
double* A;  
A = (double*)  
    malloc(N * sizeof(double));  
  
for (int i = 0; i < N; i++) {  
    A[i] = 0.0;  
}
```

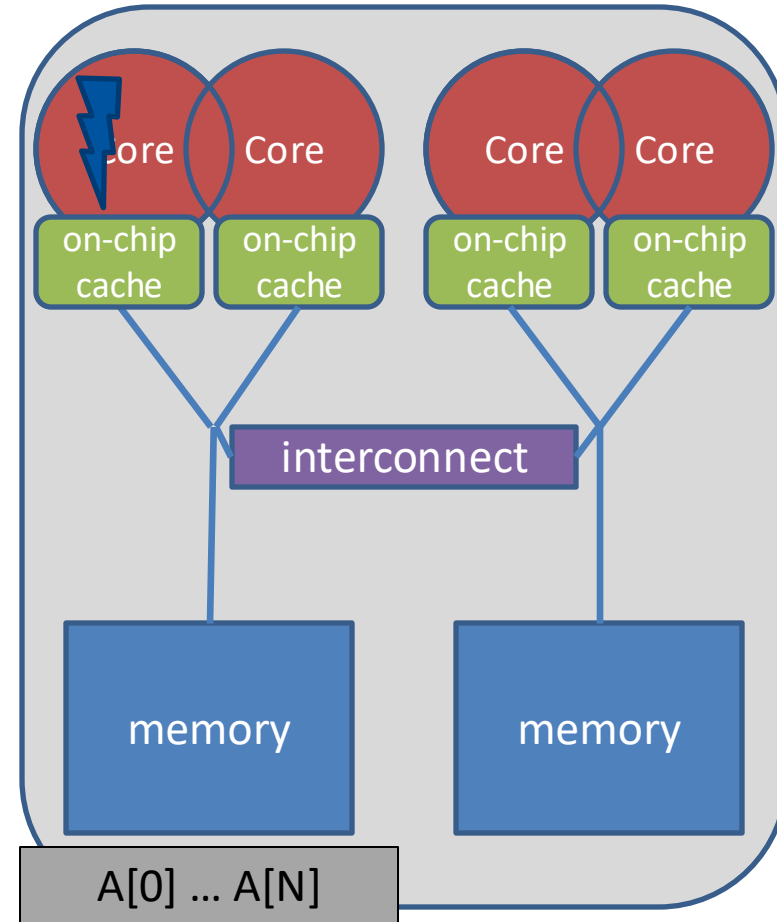

About Data Distribution

- Important aspect on cc-NUMA systems
 - If not optimal, longer memory access times and hotspots
- Placement comes from the Operating System
 - This is therefore Operating System dependent
- Windows, Linux and Solaris all use the “First Touch” placement policy by default
 - May be possible to override default (check the docs)

Non-uniform Memory

- **Serial code: all array elements are allocated in the memory of the NUMA node closest to the core executing the initializer thread (first touch)**

```
double* A;  
A = (double*)  
    malloc(N * sizeof(double));  
  
for (int i = 0; i < N; i++) {  
    A[i] = 0.0;  
}
```

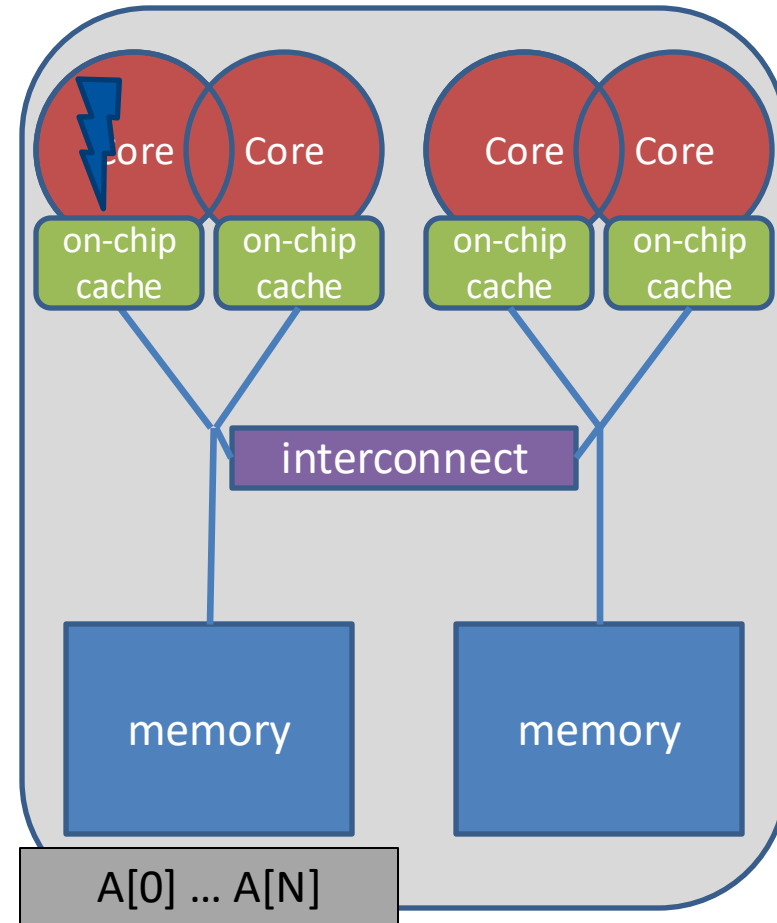

First Touch Memory Placement

- **First Touch w/ parallel code: all array elements are allocated in the memory of the NUMA node that contains the core that executes the thread that initializes the partition**

```
double* A;  
A = (double*)  
    malloc(N * sizeof(double));  
  
omp_set_num_threads(2);  
  
#pragma omp parallel for  
for (int i = 0; i < N; i++) {  
    A[i] = 0.0;  
}
```

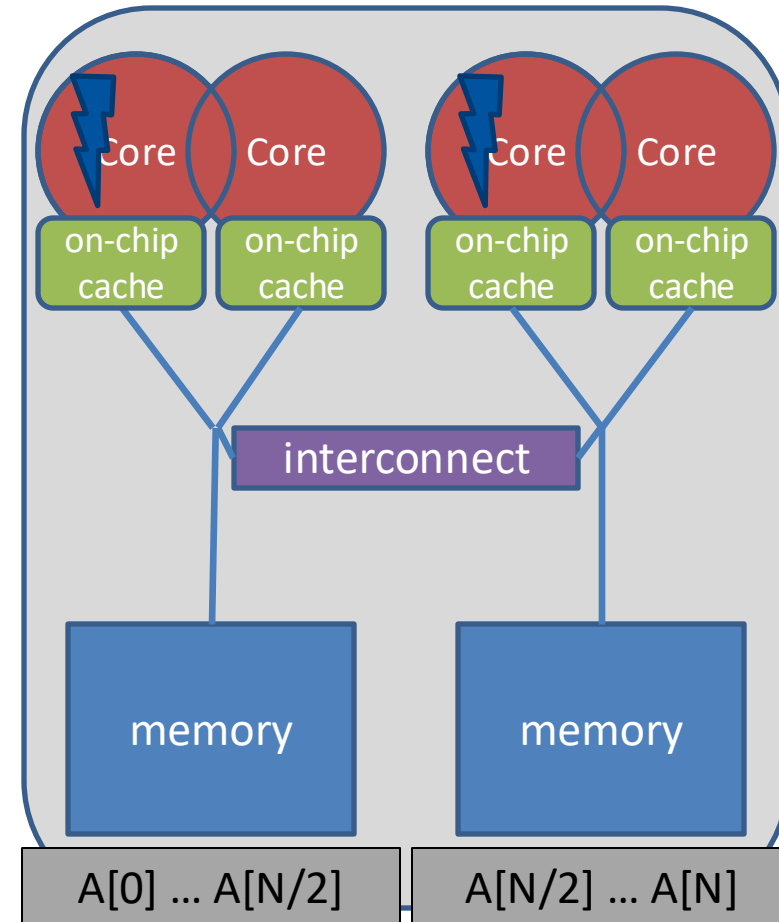

Serial vs. Parallel Initialization

- Stream example on 2 socket system with Xeon X5675 processors, 12 OpenMP threads:

	copy	scale	add	triad
ser_init	18.8 GB/s	18.5 GB/s	18.1 GB/s	18.2 GB/s
par_init	41.3 GB/s	39.3 GB/s	40.3 GB/s	40.4 GB/s

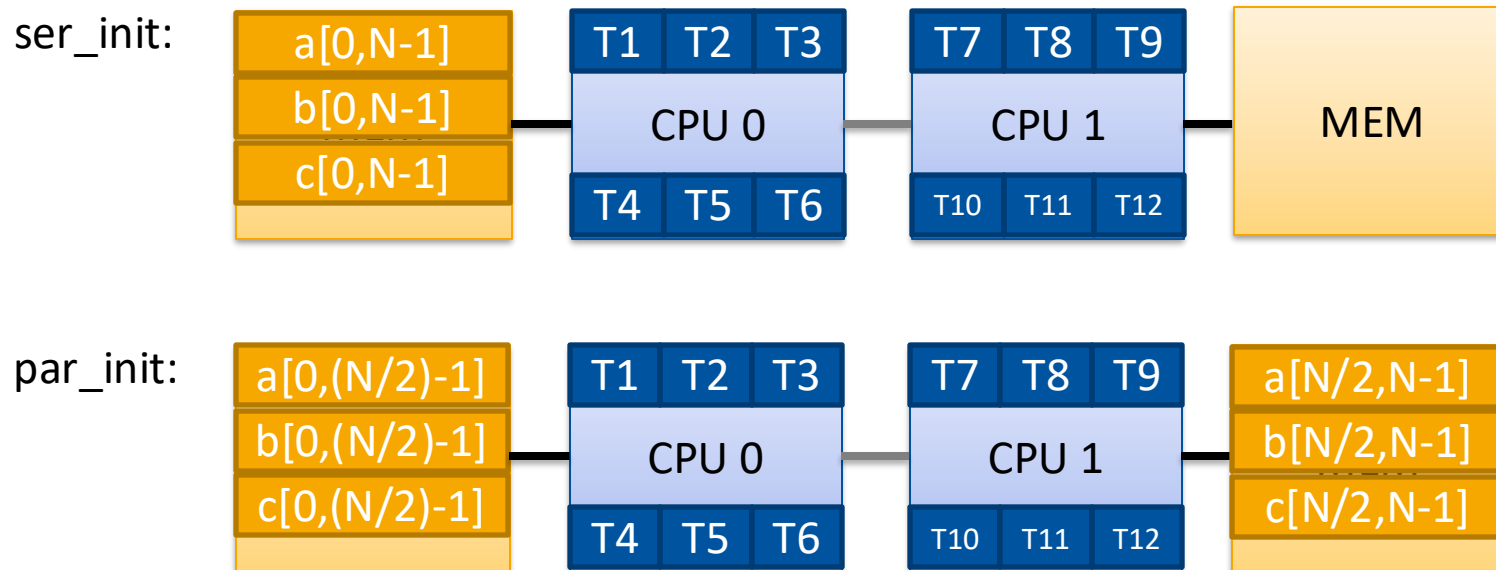

Get Info on the System Topology

- Before you design a strategy for thread binding, you should have a basic understanding of the system topology. Please use one of the following options on a target machine:
 - Intel MPI's `cpuinfo` tool
 - `cpuinfo`
 - Delivers information about the number of sockets (= packages) and the mapping of processor ids to cpu cores that the OS uses.
 - `hwloc`'s `hwloc-ls` tool
 - `hwloc-ls`
 - Displays a graphical representation of the system topology, separated into NUMA nodes, along with the mapping of processor ids to cpu cores that the OS uses and additional info on caches.

Decide for Binding Strategy

- Selecting the „right“ binding strategy depends not only on the topology, but also on application characteristics.
 - Putting threads far apart, i.e., on different sockets
 - May improve aggregated memory bandwidth available to application
 - May improve the combined cache size available to your application
 - May decrease performance of synchronization constructs
 - Putting threads close together, i.e., on two adjacent cores that possibly share some caches
 - May improve performance of synchronization constructs
 - May decrease the available memory bandwidth and cache size

Places + Binding Policies (1/2)

■ Define OpenMP Places

- set of OpenMP threads running on one or more processors
- can be defined by the user, i.e. `OMP_PLACES=cores`

■ Define a set of OpenMP Thread Affinity Policies

- SPREAD: spread OpenMP threads evenly among the places, partition the place list
- CLOSE: pack OpenMP threads near master thread
- MASTER: collocate OpenMP thread with master thread

■ Goals

- user has a way to specify where to execute OpenMP threads
- locality between OpenMP threads / less false sharing / memory bandwidth

- Assume the following machine:

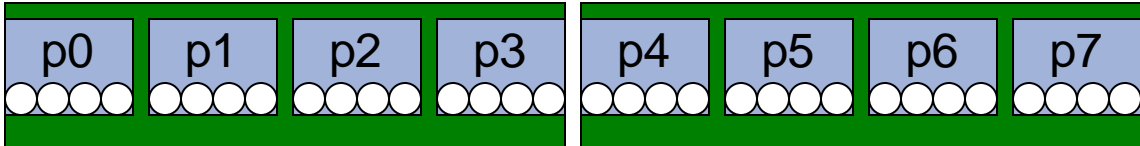

→ 2 sockets, 4 cores per socket, 4 hyper-threads per core

- Abstract names for OMP_PLACES:

→ threads: Each place corresponds to a single hardware thread on the target machine.

→ cores: Each place corresponds to a single core (having one or more hardware threads) on the target machine.

→ sockets: Each place corresponds to a single socket (consisting of one or more cores) on the target machine.

→ ll_caches: Each place corresponds to a set of cores that share the last level cache.

→ numa_domains: Each place corresponds to a set of cores for which their closest memory is: the same memory; and at a similar distance from the cores.

Places + Binding Policies (2/2)

■ Example's Objective:

→ separate cores for outer loop and near cores for inner loop

■ Outer Parallel Region: `proc_bind(spread) num_threads(4)`

Inner Parallel Region: `proc_bind(close) num_threads(4)`

→ spread creates partition, compact binds threads within respective partition

```
OMP_PLACES=(0,1,2,3), (4,5,6,7), ... = (0-3):8:4 = cores
#pragma omp parallel proc_bind(spread) num_threads(4)
#pragma omp parallel proc_bind(close) num_threads(4)
```

■ Example

→ initial

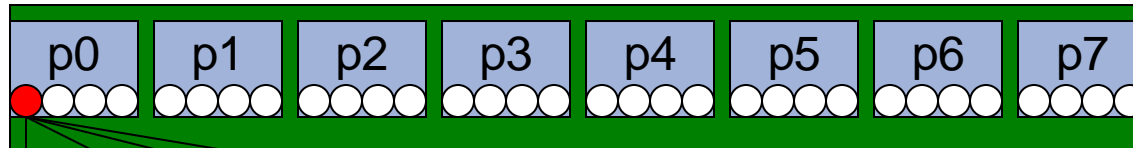

→ spread 4

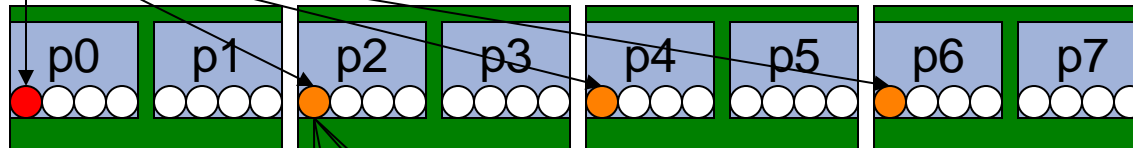

→ close 4

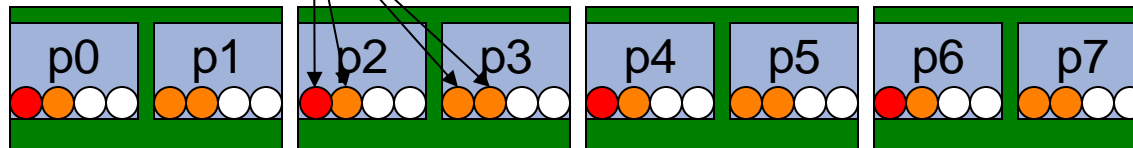

More Examples (1/3)

- Assume the following machine:

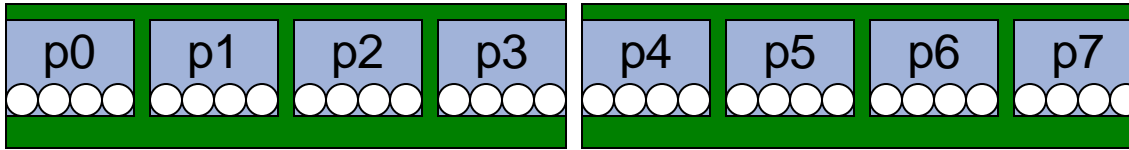

→ 2 sockets, 4 cores per socket, 4 hyper-threads per core

- Parallel Region with two threads, one per socket

→ `OMP_PLACES=sockets`

→ `#pragma omp parallel num_threads(2) proc_bind(spread)`

More Examples (2/3)

- Assume the following machine:

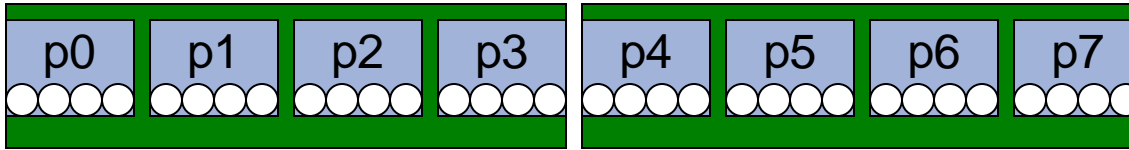

- Parallel Region with four threads, one per core, but only on the first socket

→ `OMP_PLACES=cores`

→ `#pragma omp parallel num_threads(4) proc_bind(close)`

More Examples (3/3)

- Spread a nested loop first across two sockets, then among the cores within each socket, only one thread per core

→ `OMP_PLACES=cores`

→ `#pragma omp parallel num_threads(2) proc_bind(spread)`

→ `#pragma omp parallel num_threads(4) proc_bind(close)`

Working with OpenMP Places

Places API (1/2)

- 1: Query information about binding and a single place of all places with ids 0 ... `omp_get_num_places()`:
- `omp_proc_bind_t omp_get_proc_bind()`: returns the thread affinity policy (`omp_proc_bind_false`, `true`, `master`, ...)
- `int omp_get_num_places()`: returns the number of places
- `int omp_get_place_num_procs(int place_num)`: returns the number of processors in the given place
- `void omp_get_place_proc_ids(int place_num, int* ids)`: returns the ids of the processors in the given place

Places API (2/2)

- 2: Query information about the place partition:
- `int omp_get_place_num()`: returns the place number of the place to which the current thread is bound
- `int omp_get_partition_num_places()`: returns the number of places in the current partition
- `void omp_get_partition_place_nums(int* pns)`: returns the list of place numbers corresponding to the places in the current partition

Places API: Example

- Simple routine printing the processor ids of the place the calling thread is bound to:

```
void print_binding_info() {
    int my_place = omp_get_place_num();
    int place_num_procs = omp_get_place_num_procs(my_place);

    printf("Place consists of %d processors: ", place_num_procs);

    int *place_processors = malloc(sizeof(int) * place_num_procs);
    omp_get_place_proc_ids(my_place, place_processors)

    for (int i = 0; i < place_num_procs - 1; i++) {
        printf("%d ", place_processors[i]);
    }
    printf("\n");

    free(place_processors);
}
```

OpenMP 5.0 way to do this

■ Set `OMP_DISPLAY_AFFINITY=TRUE`

→ Instructs the runtime to display formatted affinity information

→ Example output for two threads on two physical cores:

```
nesting_level= 1,  thread_num= 0,  thread_affinity= 0,1
nesting_level= 1,  thread_num= 1,  thread_affinity= 2,3
```

→ Output can be formatted with `OMP_AFFINITY_FORMAT` env var or corresponding routine

→ Formatted affinity information can be printed with

```
omp_display_affinity(const char* format)
```

Affinity format specification

t	omp_get_team_num()	a	omp_get_ancestor_thread_num() at level-1
T	omp_get_num_teams()	H	hostname
L	omp_get_level()	P	process identifier
n	omp_get_thread_num()	i	native thread identifier
N	omp_get_num_threads()	A	thread affinity: list of processors (cores)

■ Example:

```
OMP_AFFINITY_FORMAT="Affinity: %0.3L %.8n %.15{A} %.12H"
```

→ Possible output:

```
Affinity: 001          0          0-1,16-17          host003
Affinity: 001          1          2-3,18-19          host003
```

A first summary

A first summary

- Everything under control?
- In principle Yes, but only if
 - threads can be bound explicitly,
 - data can be placed well by first-touch, or can be migrated,
 - you focus on a specific platform (= OS + arch) → no portability

- What if the data access pattern changes over time?

- What if you use more than one level of parallelism?

- **First Touch:** Modern operating systems (i.e., Linux \geq 2.4) decide for a physical location of a memory page during the first page fault, when the page is first „touched“, and put it close to the CPU causing the page fault.
- **Explicit Migration:** Selected regions of memory (pages) are moved from one NUMA node to another via explicit OS syscall.
- **Automatic Migration:** Limited support in current Linux systems.
 - Not made for HPC and disabled on most HPC systems.

User Control of Memory Affinity

■ Explicit NUMA-aware memory allocation:

→ By carefully touching data by the thread which later uses it

→ By changing the default memory allocation strategy

→ Linux: `numactl` command

→ Windows: `VirtualAllocExNuma()` (limited functionality)

→ By explicit migration of memory pages

→ Linux: `move_pages()`

→ Windows: no option

■ Example: using `numactl` to distribute pages round-robin:

→ `numactl -interleave=all ./a.out`